

# Domino

## Шафа 2Д | Шкаф 2Д

### Wardrobe 2D

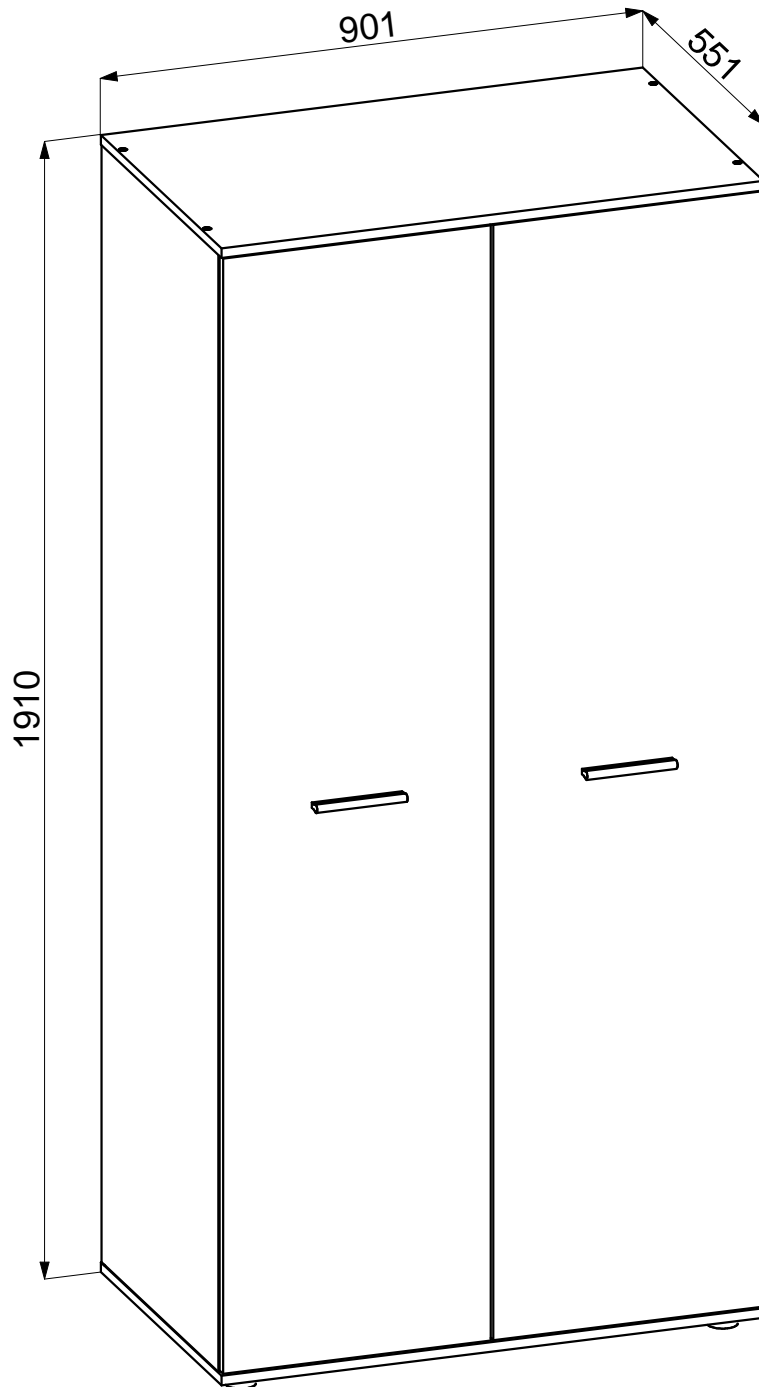













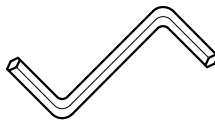
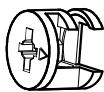
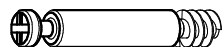



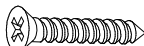

FURNITURE FACTORY

**CMF Group**  
formula of style

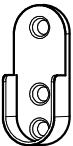
Модульна система | Модульная система | Modular system

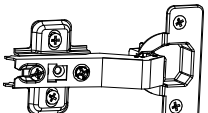

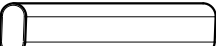
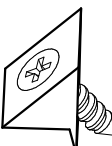

 Ø6,3x50 mm <b>A1 x 12</b>	 Ø12 mm <b>A2 x 12</b>	 4 mm <b>A3 x 1</b>	 Ø15x12 mm <b>B1 x 6</b>	 Ø5x44 mm <b>B2 x 6</b>
 Ø20 mm <b>B3 x 6</b>	 Ø12x3 mm <b>C x 2</b>	 Ø4x16 mm <b>D1 x 32</b>	 Ø4x20 mm <b>D2 x 2</b>	 Ø3x16 mm <b>D3 x 4</b>
 Ø3x25 mm <b>D4 x 19</b>	 Ø4x30 mm <b>D5 x 4</b>	 Ø8x36 mm <b>G x 4</b>	 <b>H x 2</b>	 <b>I x 2</b>
 Ø5x16 mm <b>L x 8</b>	 <b>M x 8</b>	 <b>N x 5</b>	 421 mm <b>P x 1</b>	 <b>Q x 19</b>
 <b>Z x 19</b>				

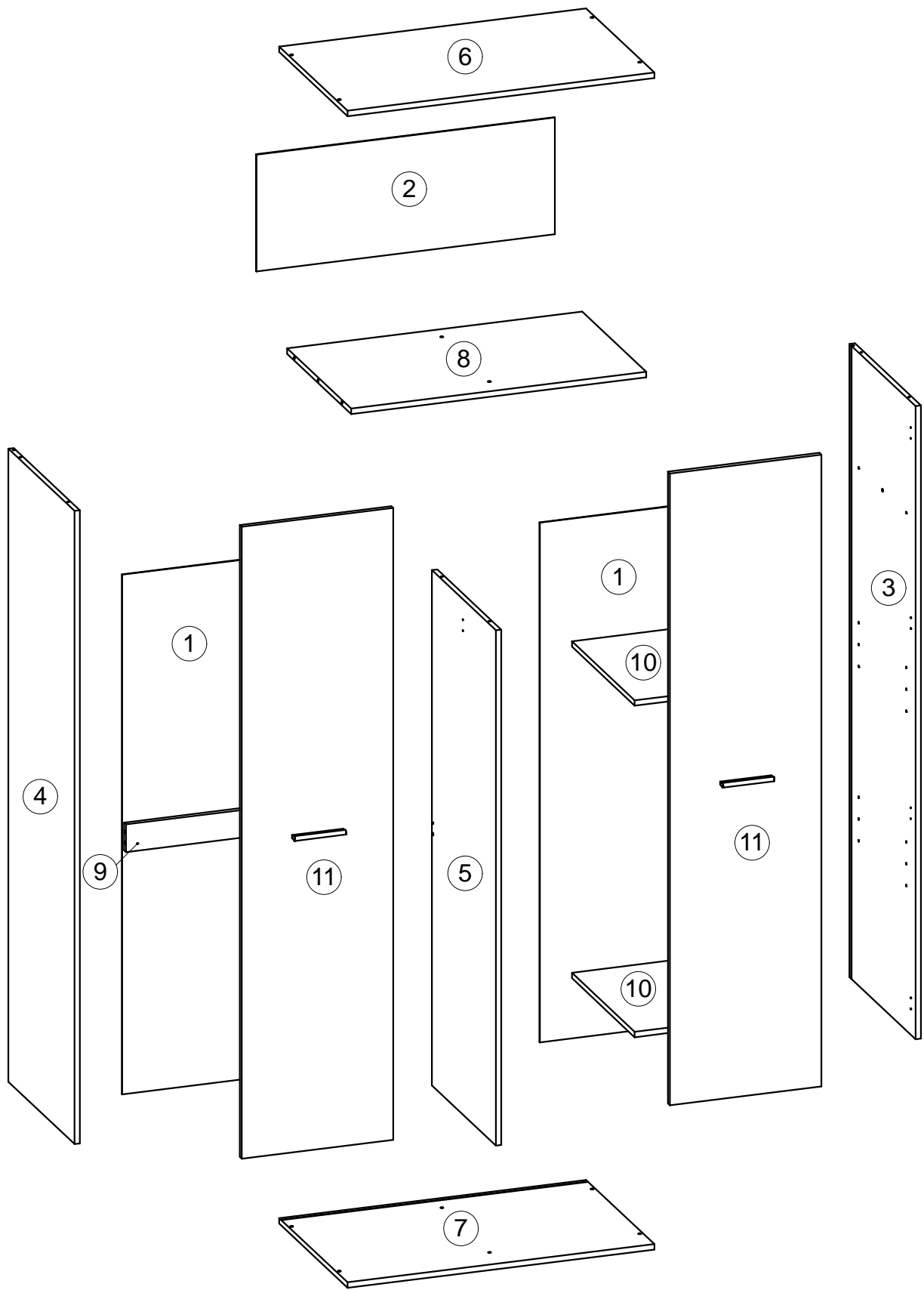

### Box 1

900x550x16 mm

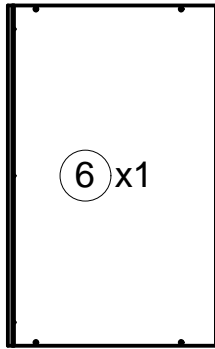

900x550x16 mm

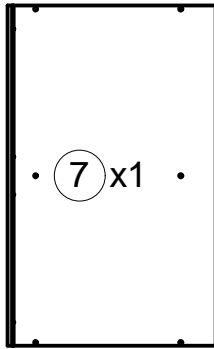

506x425x16 mm

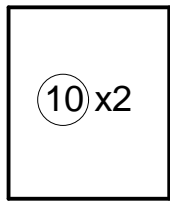

866x516x16 mm

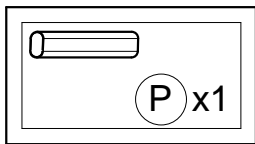
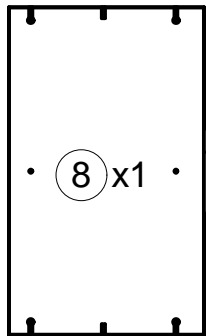

Fittings & Tools

### Box 2

1858x532x16 mm

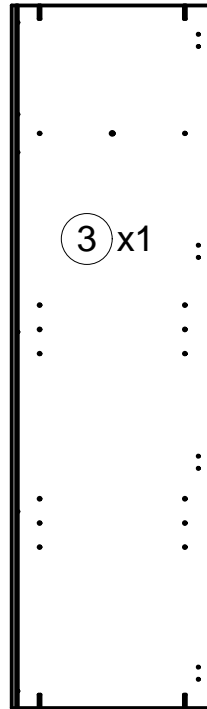

1858x532x16 mm

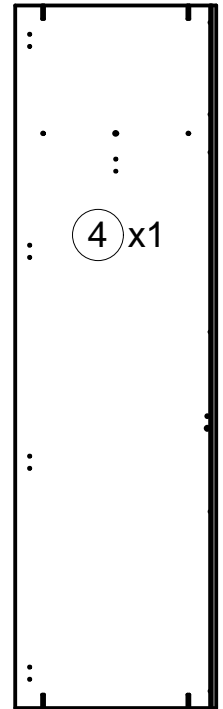

1512x516x16 mm

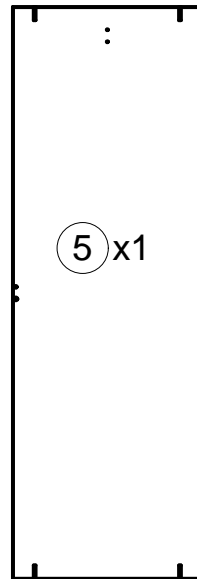

1525x438x3 mm

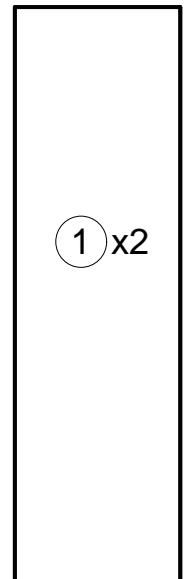

425x80x16 mm

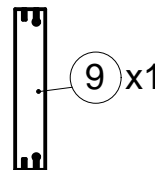

876x343x3 mm

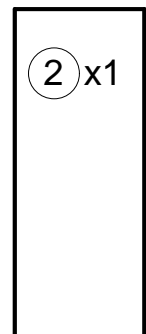

### Box 3

1853x444x16 mm

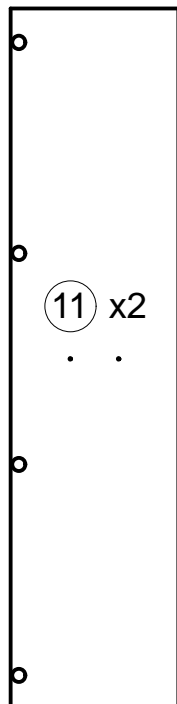

1

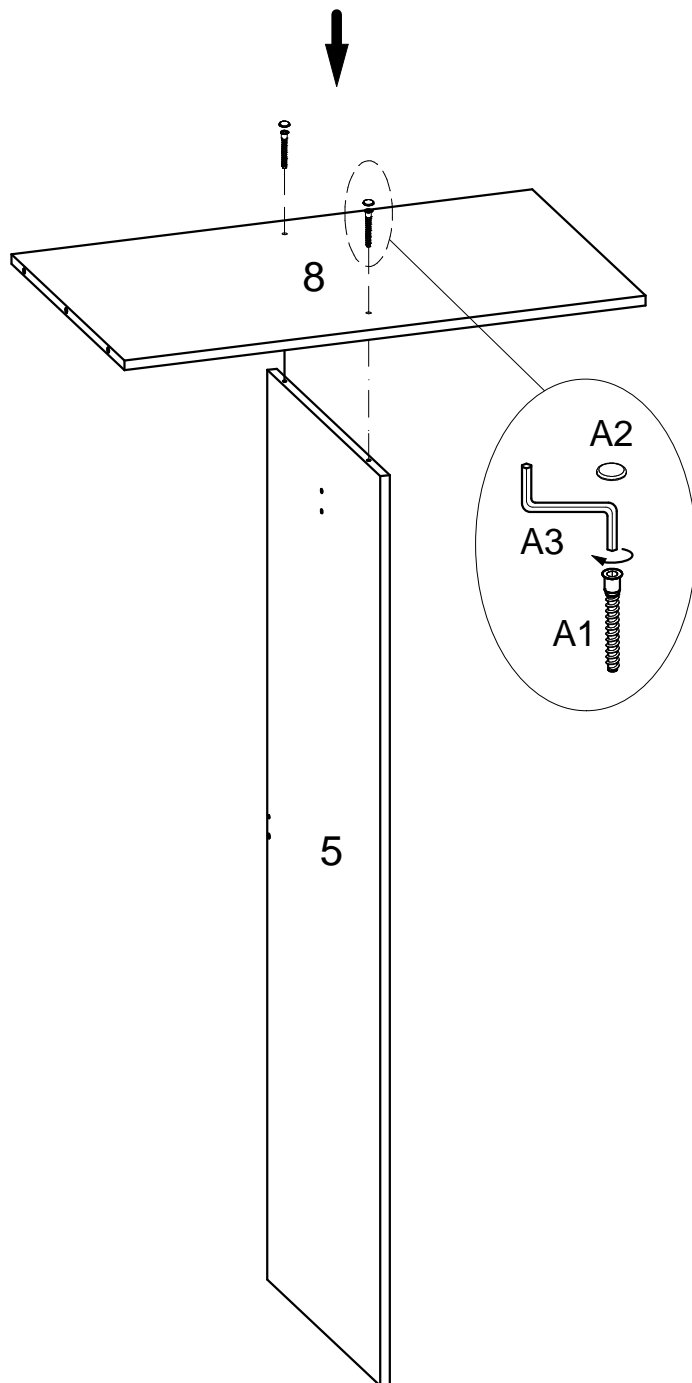

2

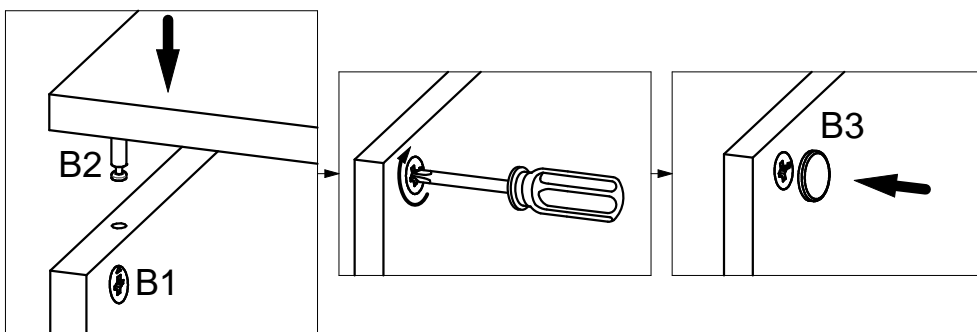
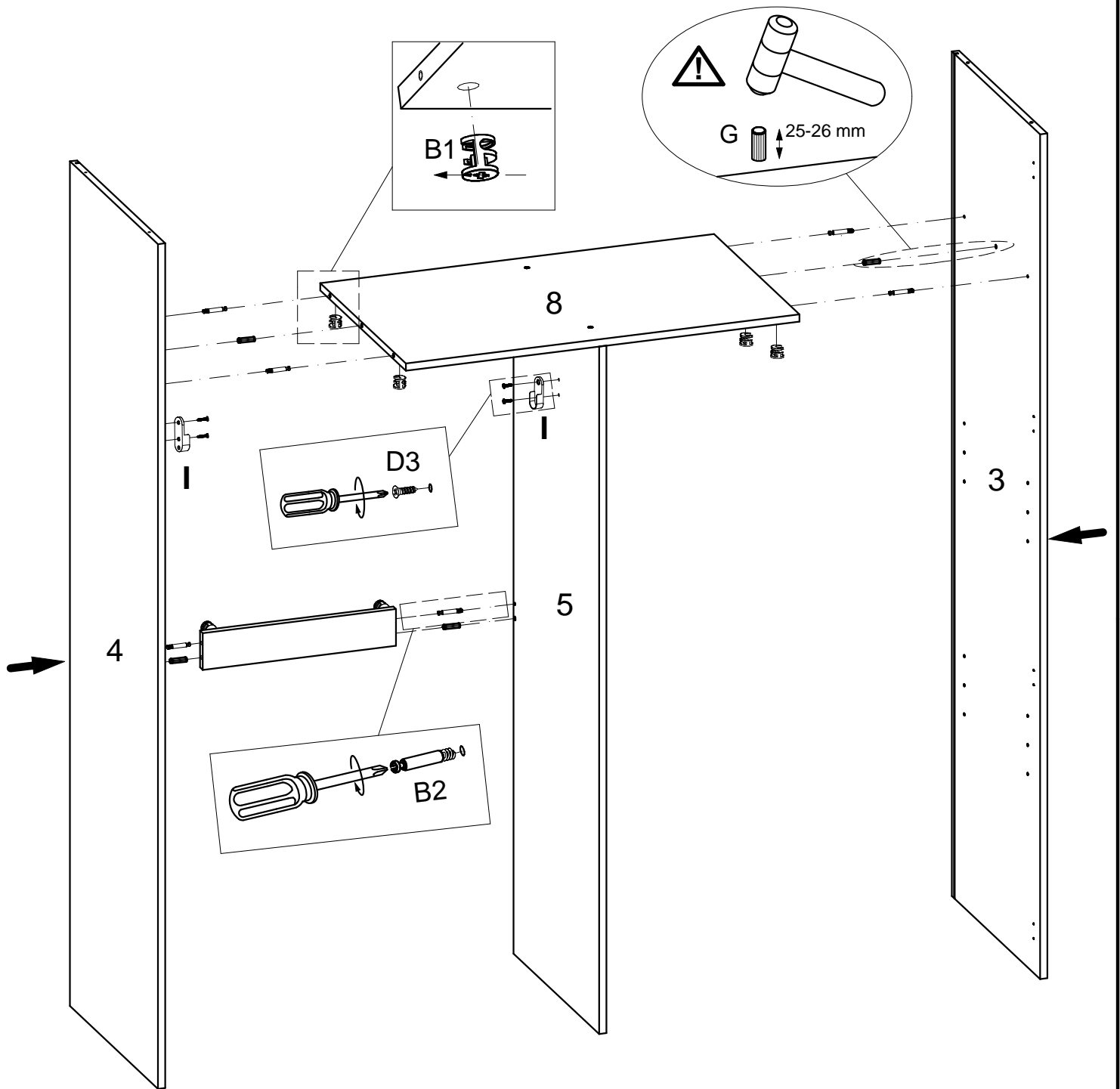
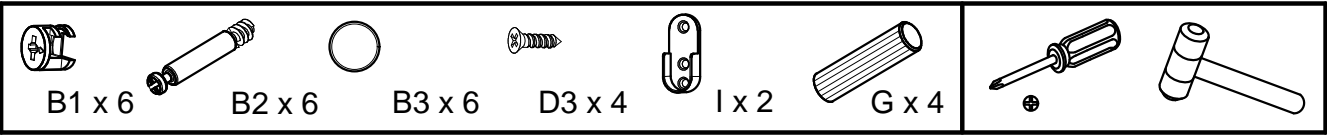

3

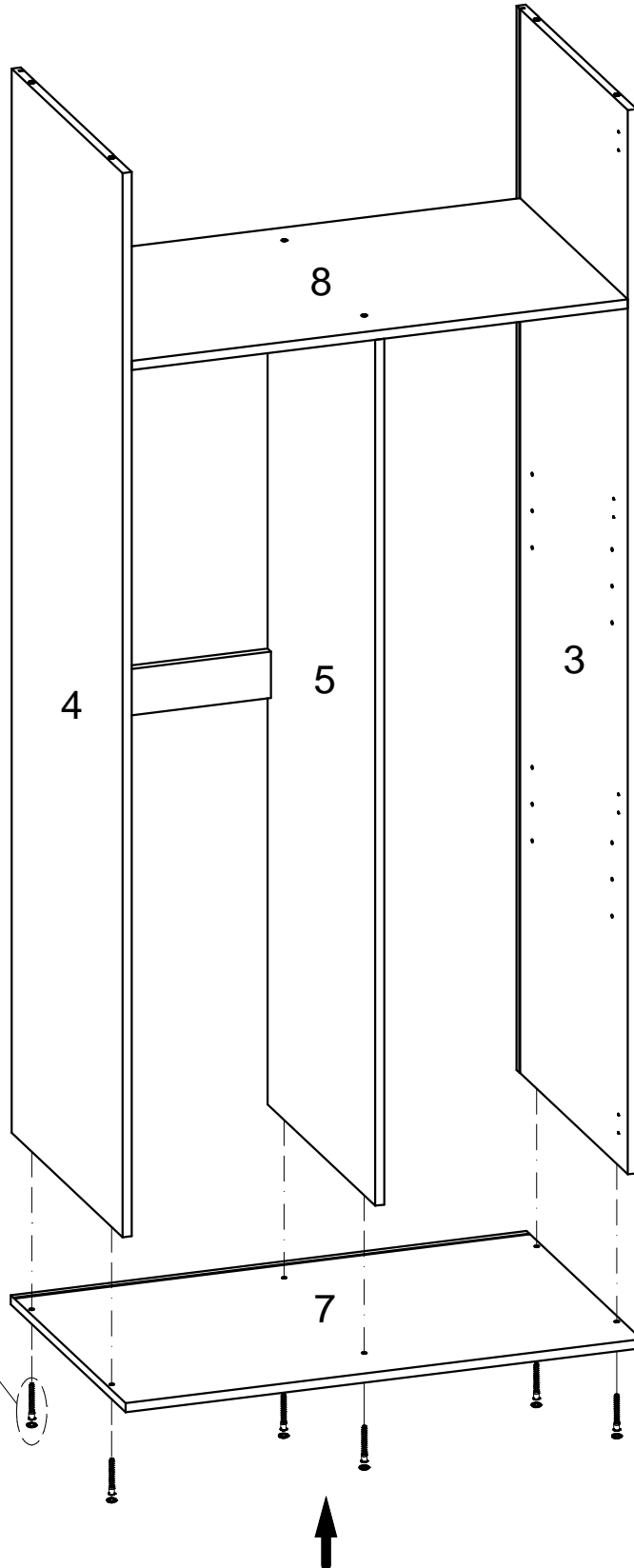
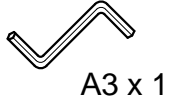
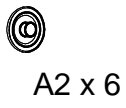



4



N x 5

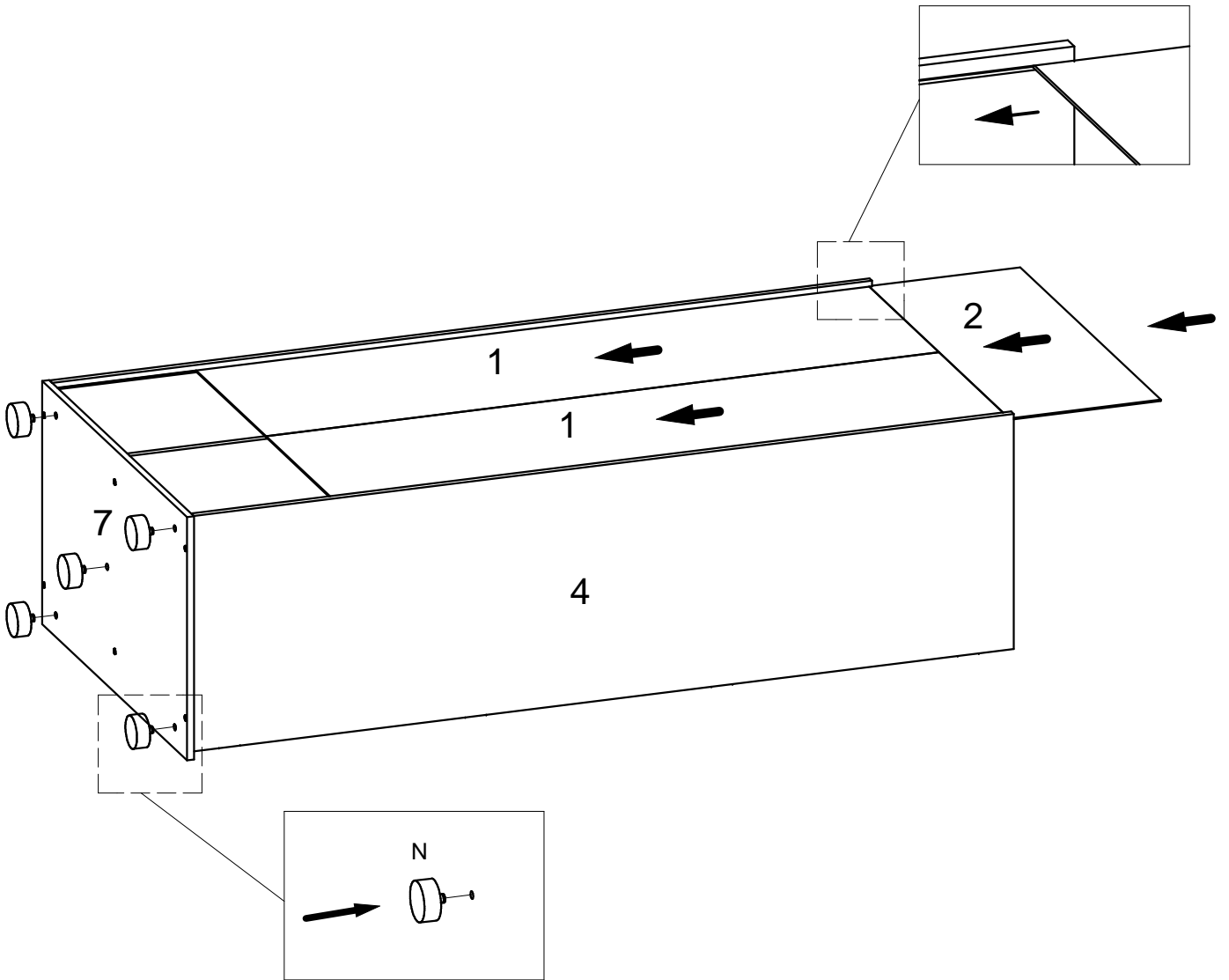

5

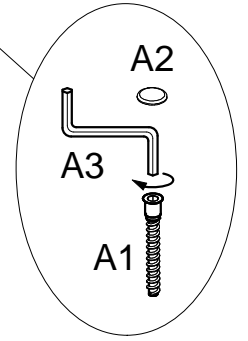
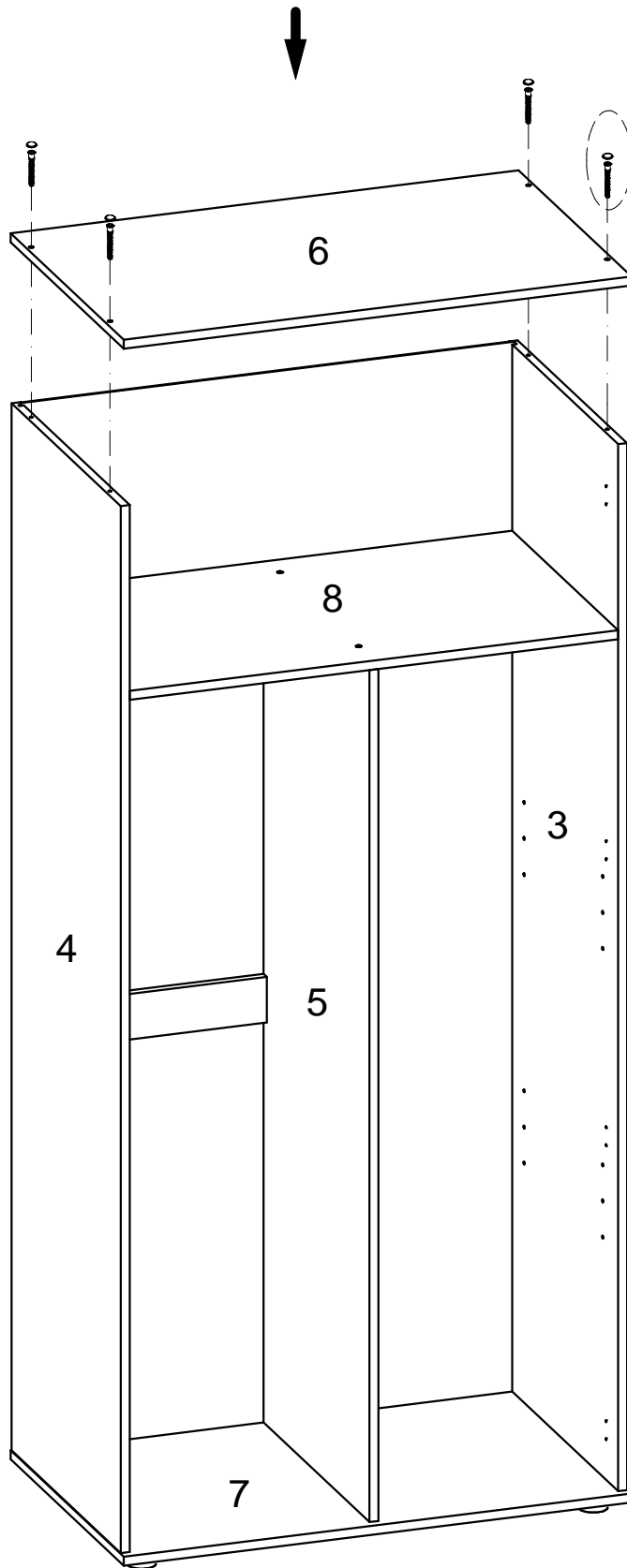
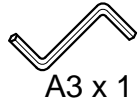
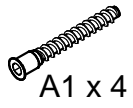

6



C x 2



D2 x 2



D4 x 19



Q x 19





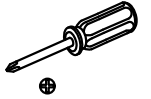
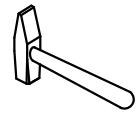

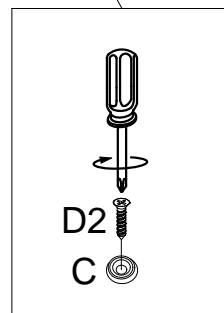
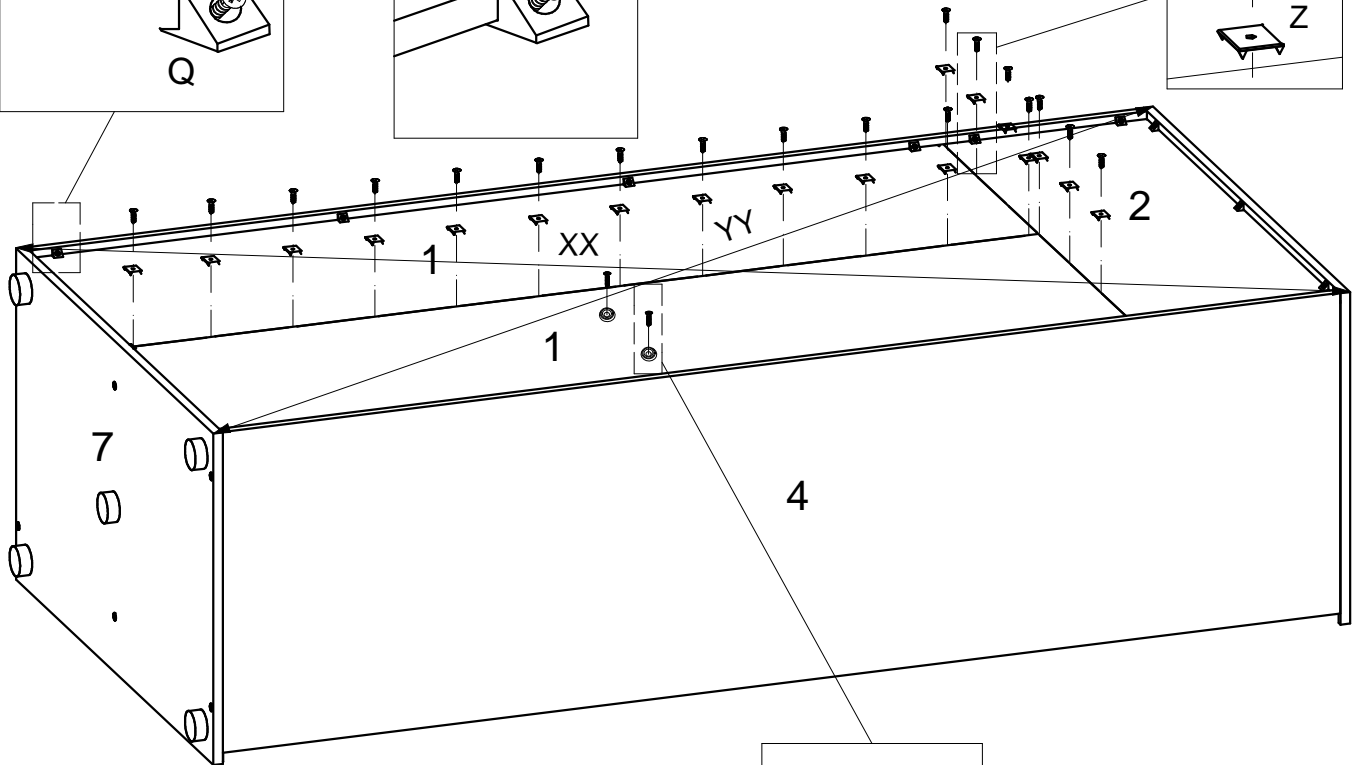
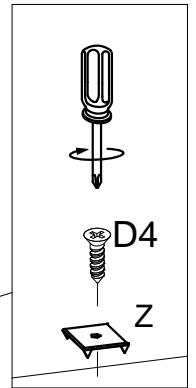
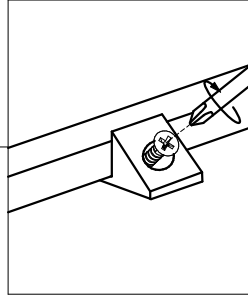
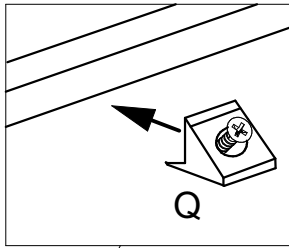

Z x 19



⚠ XX=YY≅90°

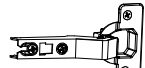

7

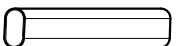
-  D1 x 32
-  D5 x 4
-  H x 2
-  L x 8
-  M.2 x 8
-  M.1 x 8
-  P x 1

