

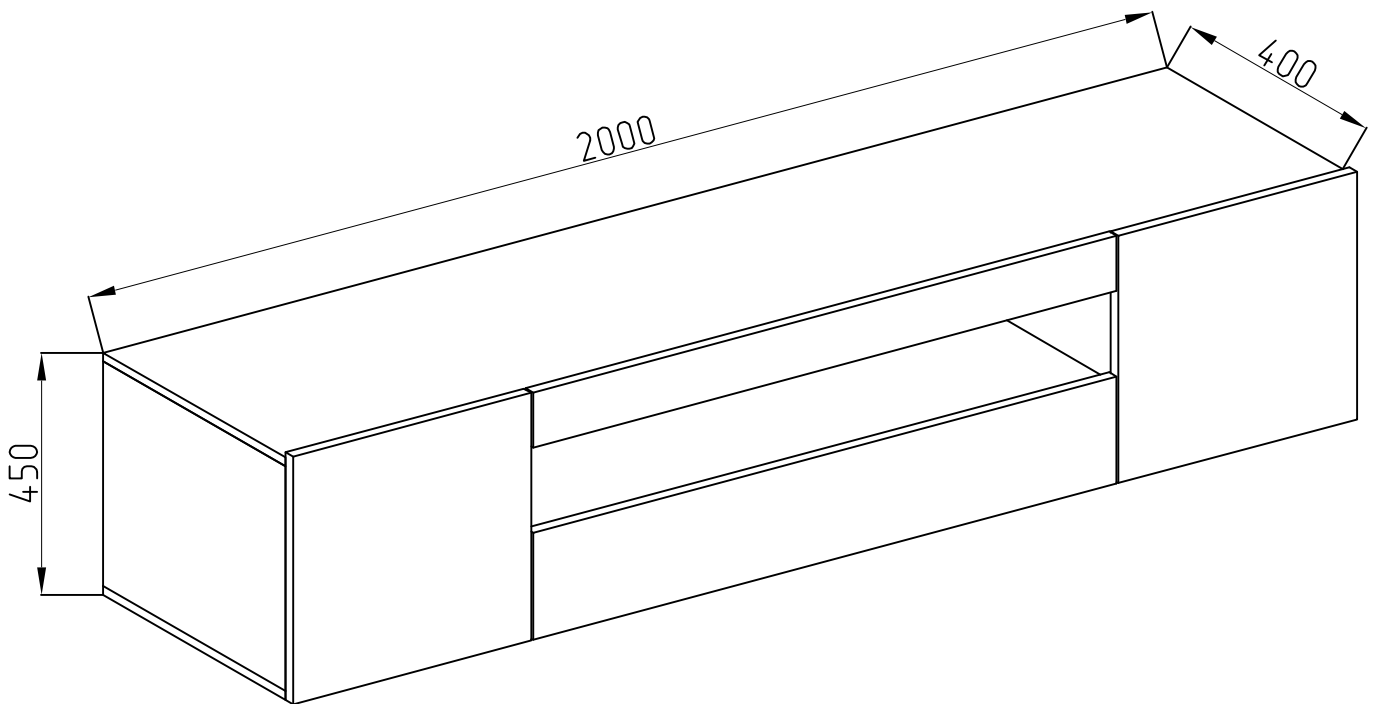

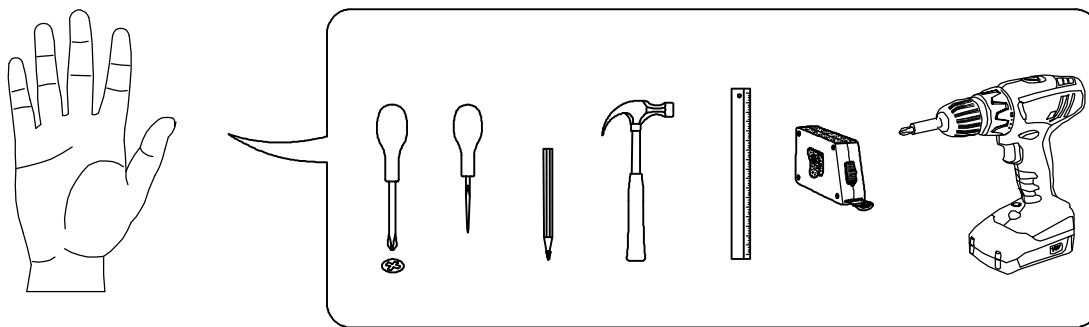

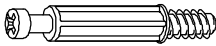





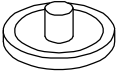

FORZE



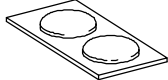

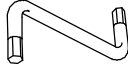
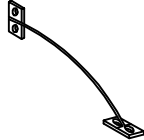



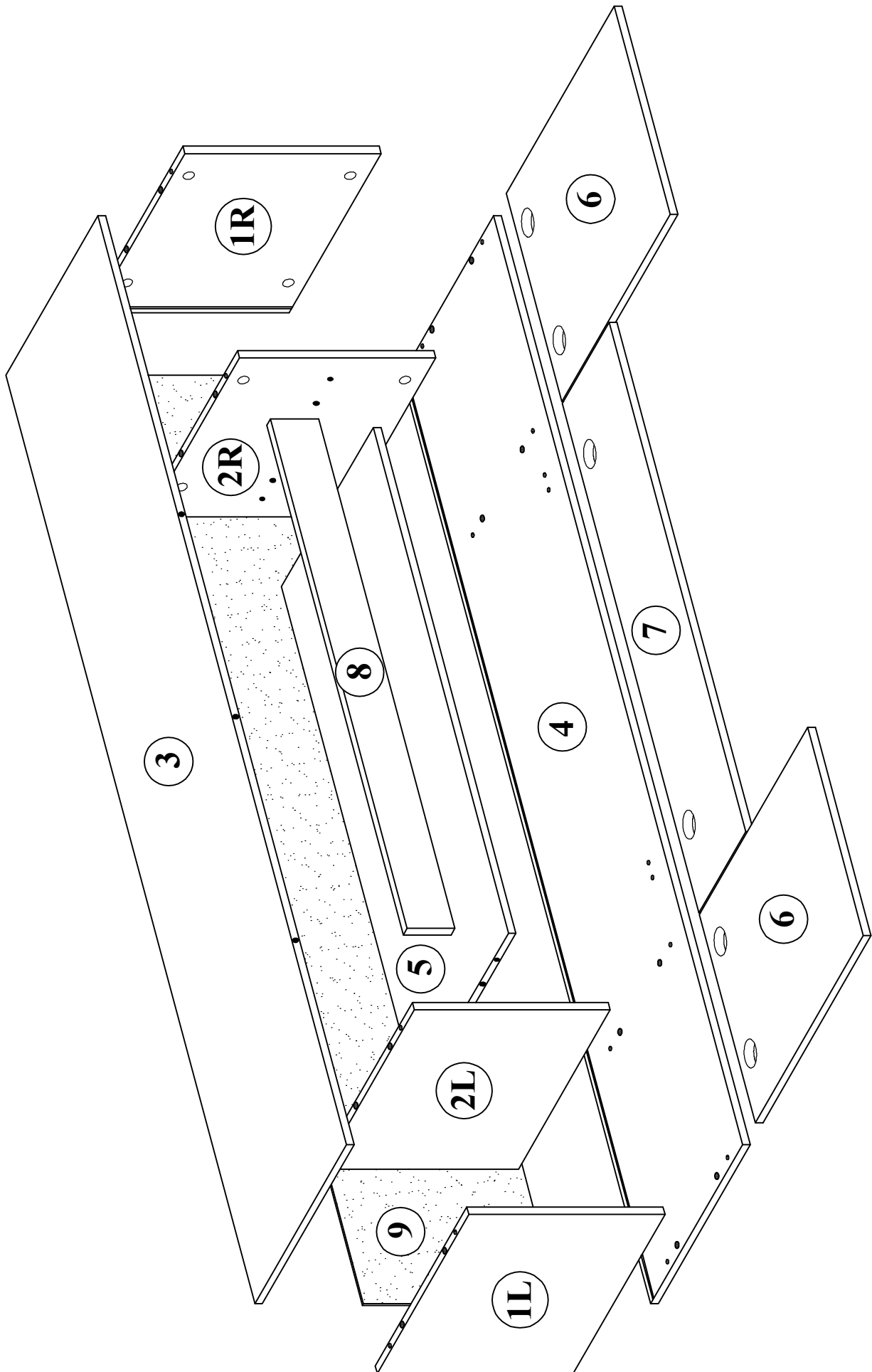

 (C1) 6*43mm x23	 (D1) 15/16 x23	 (D) ϕ 20mm x23
 (K5) x8	 (A1) 8*30mm x20	 (L1) x6
 (E10) 4*16mm x12	 (F2) 6,3*13mm x12	 (U6) x6
 (H2) x12	 (R4) N°4 x1	 (S8) x2
 (E2) 3*15mm x8		

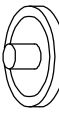
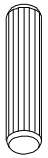
No	a*b	x
1	408x382	2
2	408x368	2
3	2000x382	1
4	2000x382	1
5	1086x368	1
6	450x448	2
7	195x1097	1
8	100x1097	1
9	1975x417	1

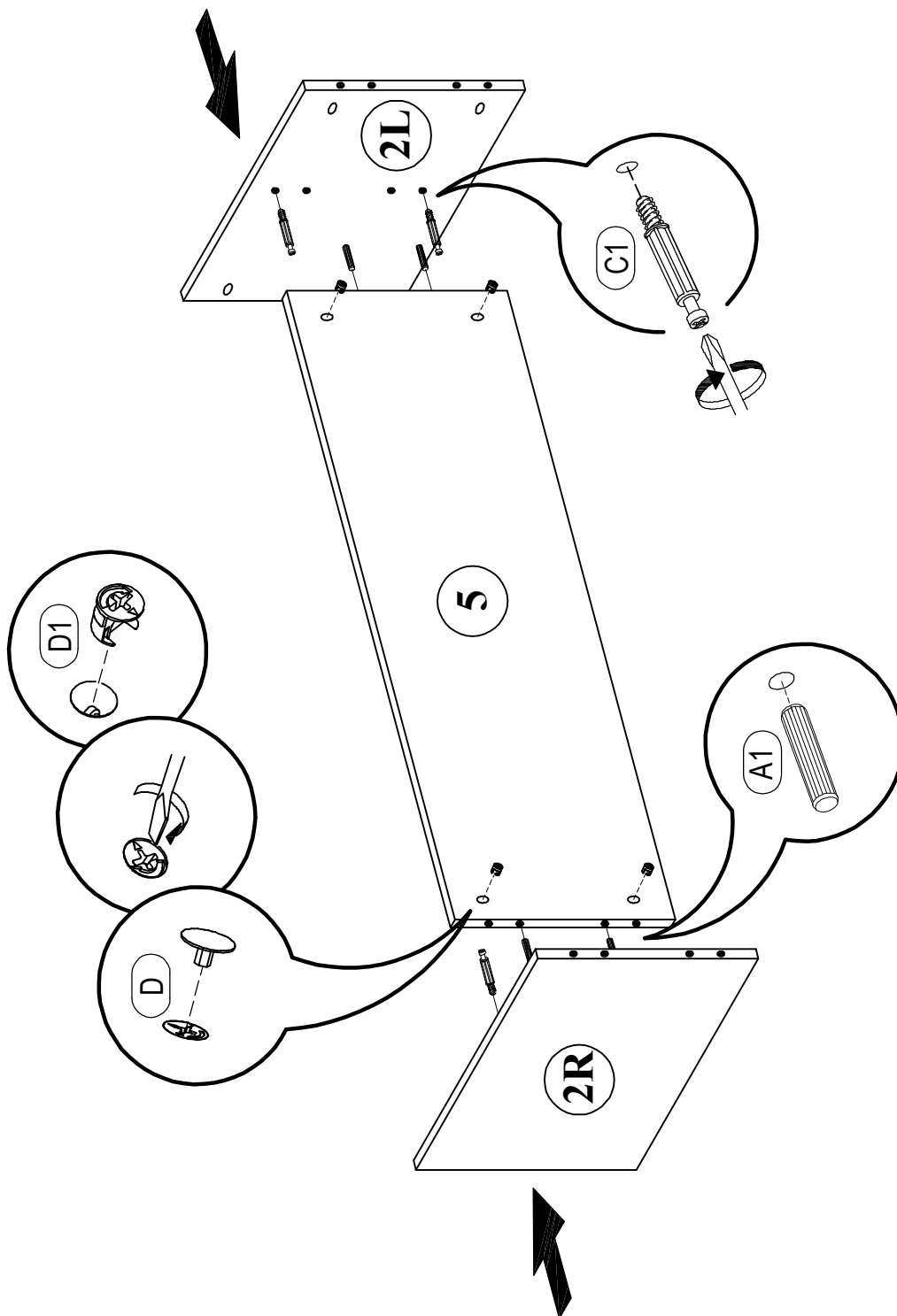



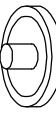

	C1	6*43mm	x4
	D1	15/16	x4
	D	φ20mm	x4
	A1	8*30mm	x4

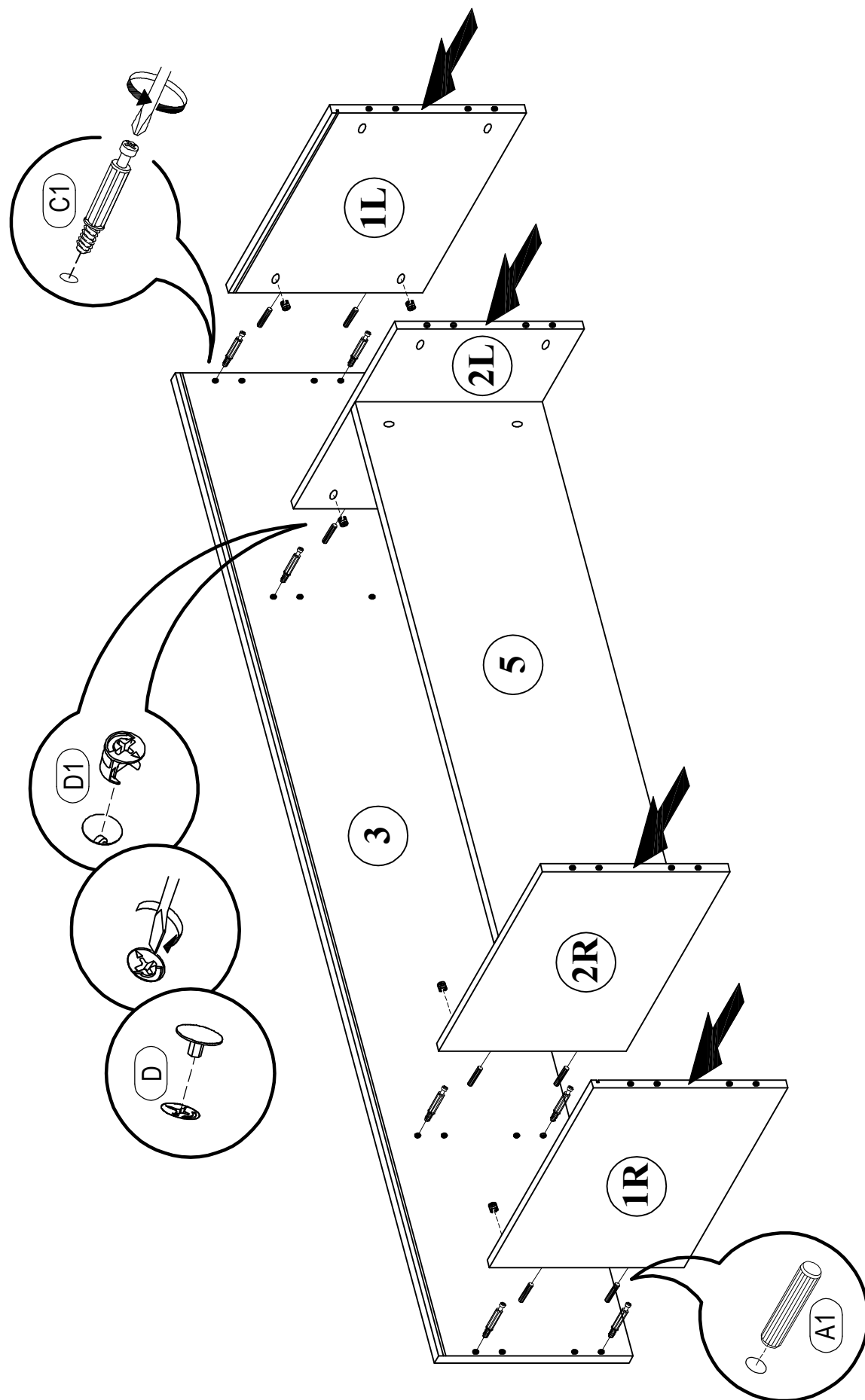

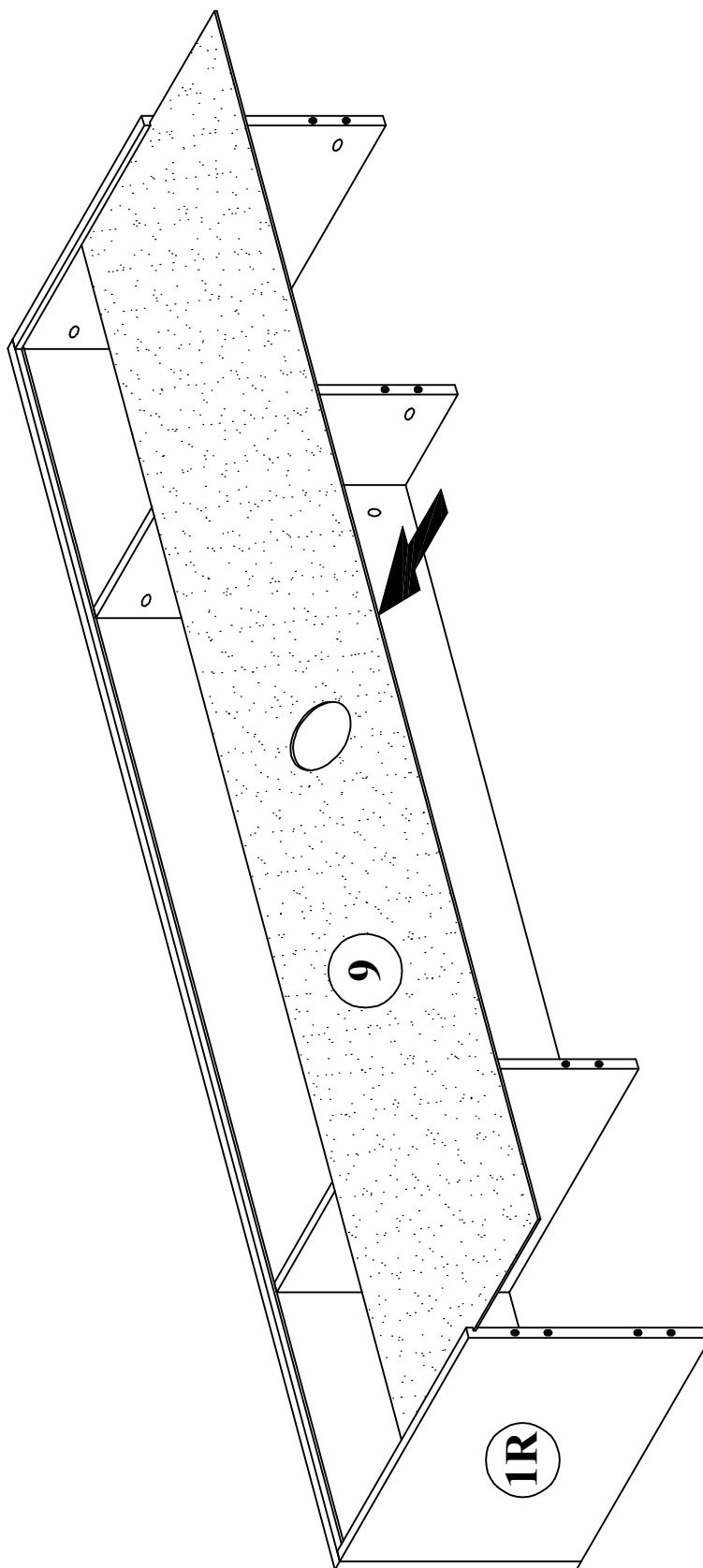

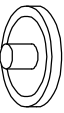

	C1	6*43mm	x8
	D1	15/16	x8
	D	φ20mm	x8
	A1	8*30mm	x8



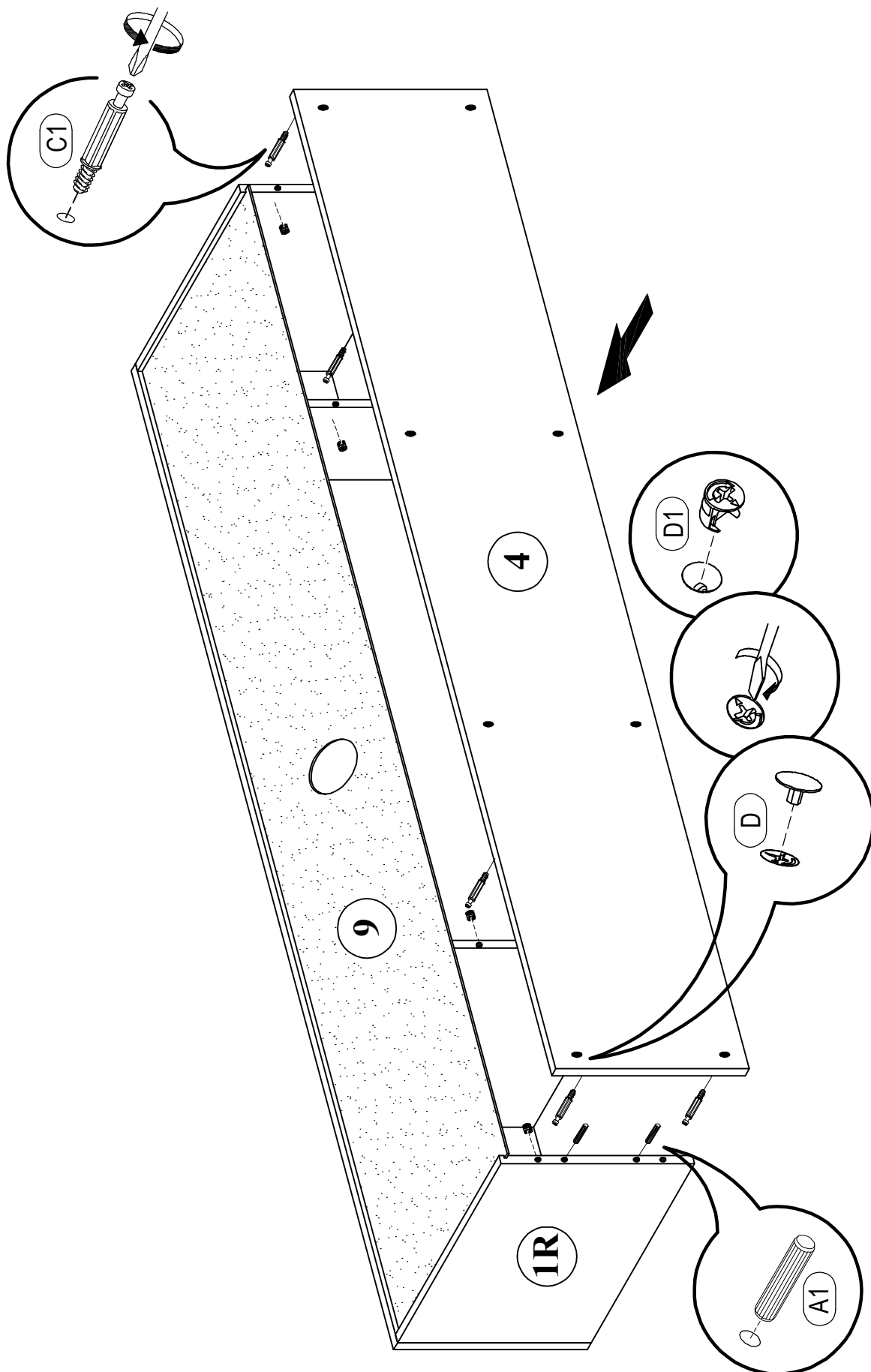

	C1	6*43mm	x8
	D1	15/16	x8
	D	φ20mm	x8
	A1	8*30mm	x8





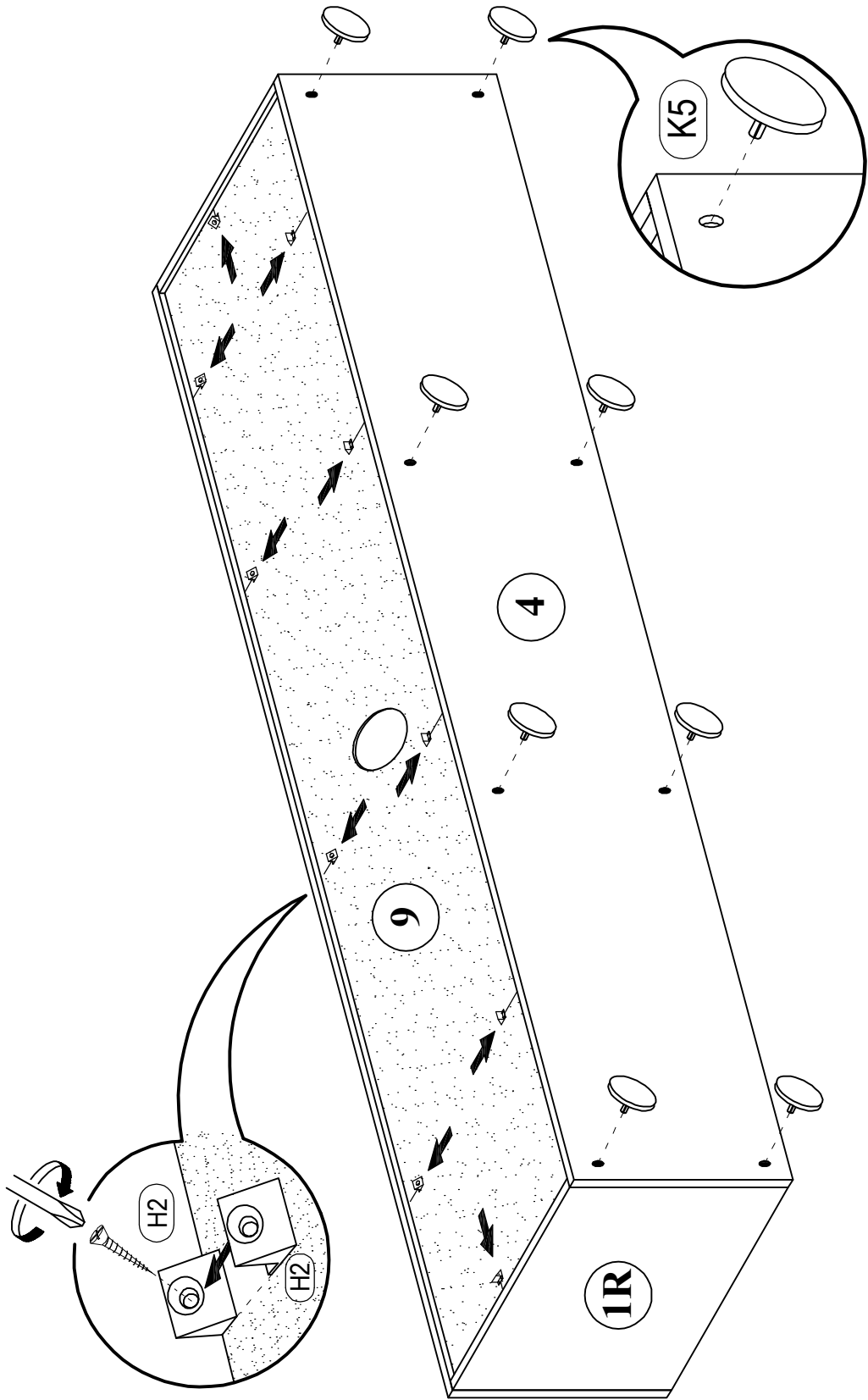

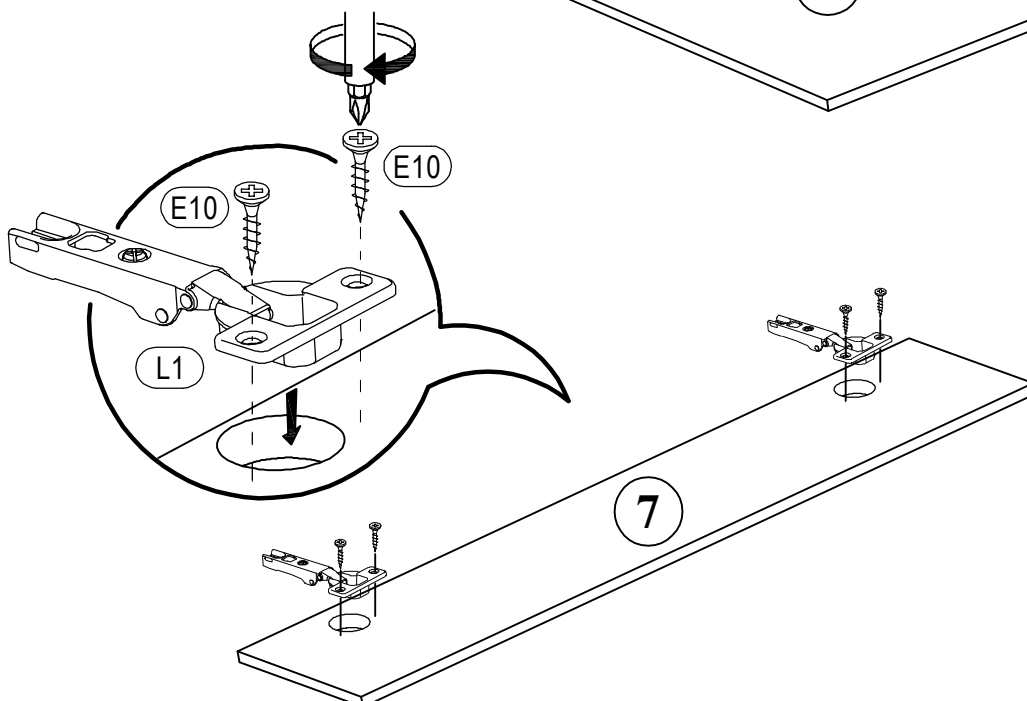
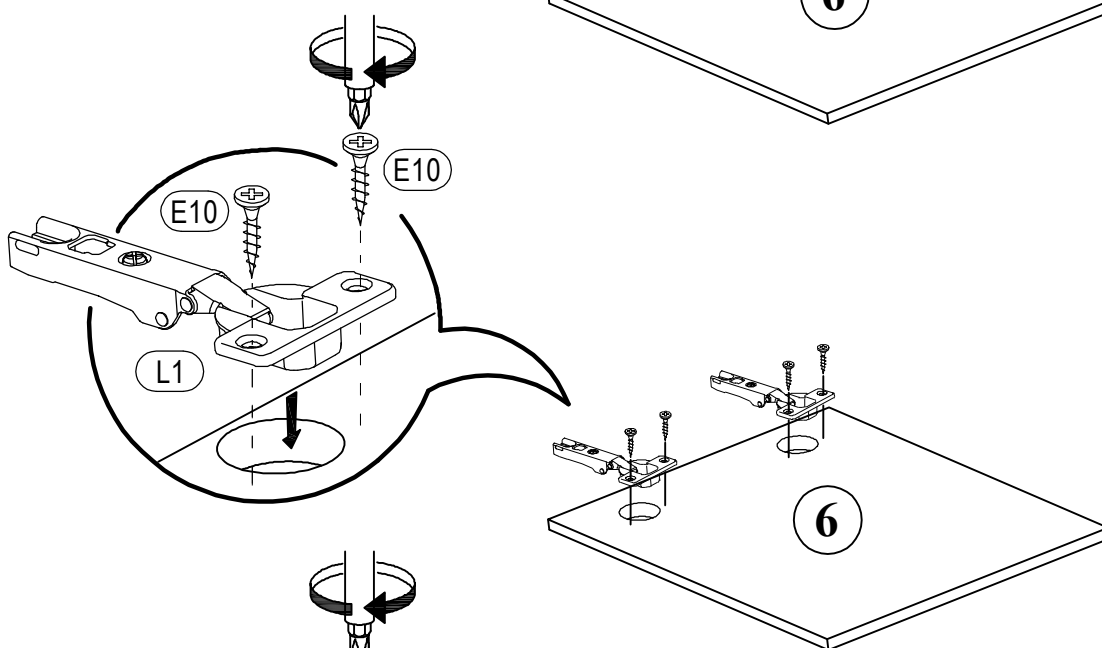
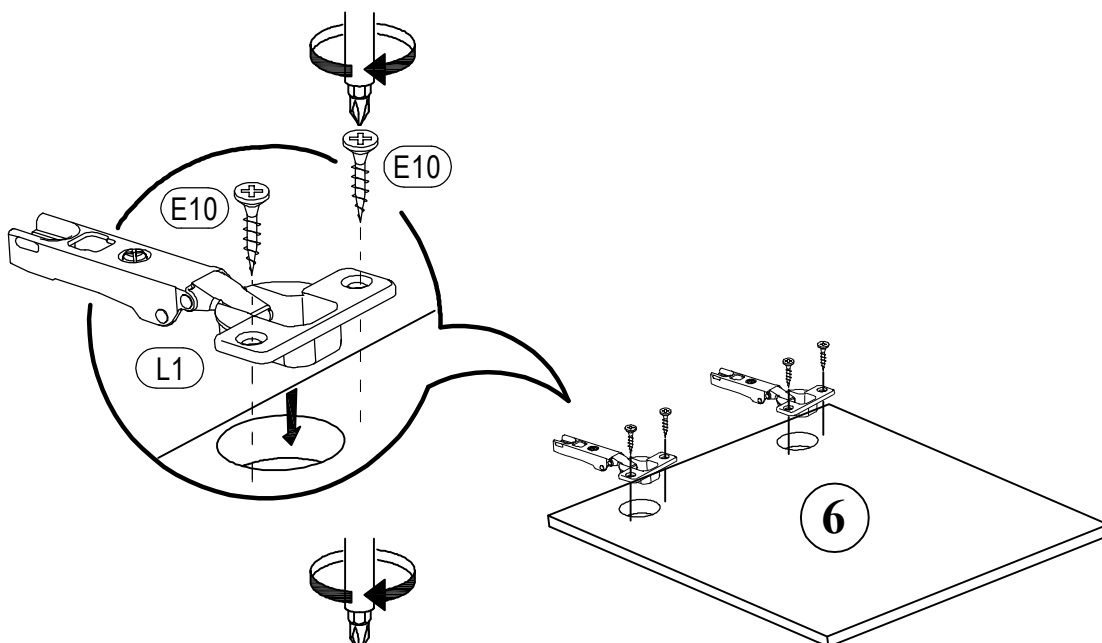
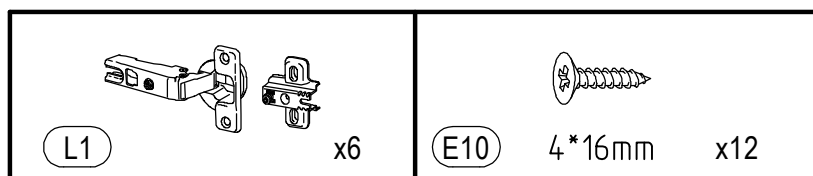
		
(K5)	x8	(H2)
		x10



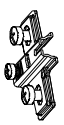

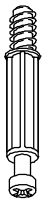

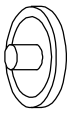
FORZE

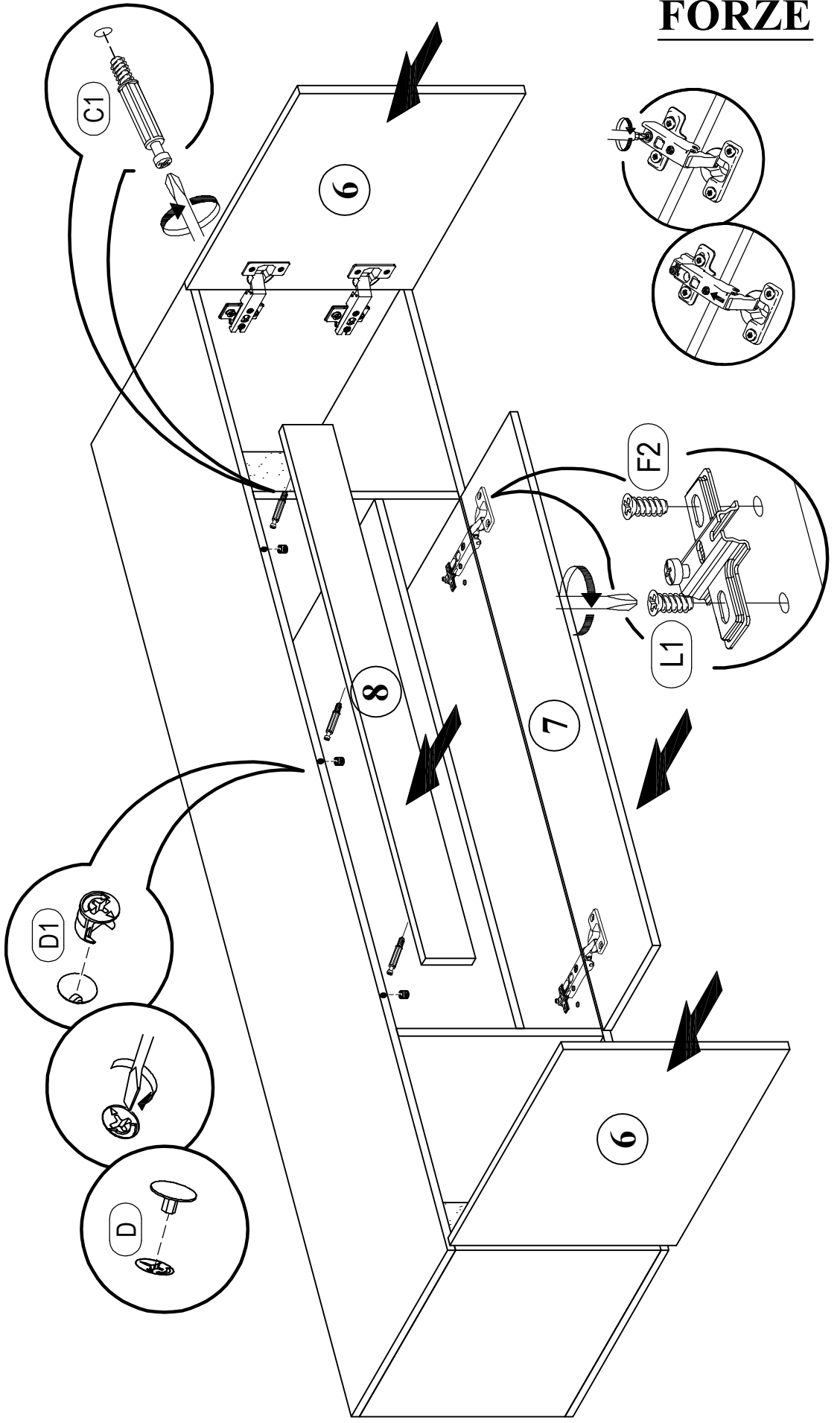
 <p>L1</p>	 <p>F2</p>	 <p>C1</p>	 <p>D1</p>	 <p>D</p>
x6	6,3*13mm x12	6*4,3mm x3	15/16 x3	ø20mm x3



	
E2	S8
3*15mm	x2
x8	

